

Analyze of the Joints Positions and the Type of Movements to the Dynamic Behavior in Robotics

Adrian Olaru

Robots and Production Systems Dept.
University Politehnica of Bucharest
Bucharest, Romania
aolaru_51@ymail.com

Serban Olaru

Mechatronics Department
METRA
Bucharest, Romania
serban1978@yahoo.com

Niculae Mihai

Mechatronics Department
Techno-Accord Ltd.
Quebec, Canada
mmiculae@yahoo.com

Abstract— The position in space of the joints of the robots, as well as the successive or simultaneous movements in the joints influence the dynamic behavior of the robots. In order to highlight these important influences on the dynamic behavior of robotic structures, a proper new software platform was created under the LabView kernel with the help of which these influences can be highlighted. Following the analysis of the current state, respectively of the software platforms Workspacelt, Robotic simulation, Ni-robotics, RoboNaut, Simrobot, Open dynamics engine, Robot studio, RoKiSim, Dart, Nvidia Physx, Bullet physics, Ros, Dynamics Engine, Gazebo, Robotech it was concluded that these platforms do not highlight these objectives, which is why the new research platform in Robotics was created. The platform named ROBO-PVAFM ensures the assisted research of the analysis of positions, velocities, accelerations, forces and moments in the joints of Articulated Arm, Cartesian, Scara, Double Portal type robots under the conditions of choosing the type of movement, materials and masses of the component bodies, approximating their mass, generating the graphs associated with the structures, generating body-joints and joints-body influence matrices, determining the tensors of inertia, determining and researching the variation of the derivative of the kinematic moment. The platform ensures the solution of the forward kinematics (FK) and the inverse dynamics (ID) of the mentioned robots, following that it will later be completed with the analysis of the inverse kinematics (IK) and the direct dynamics (DD), as well as with other types of robots and many robot's applications. The platform will be able to be used in other multi-robot applications or other mechanical applications.

Keywords—space joint position; simultaneously movements; assisted research; forward kinematics; inverse dynamics; virtual LabView instrumentation

I. INTRODUCTION

Kinematic and dynamic analyze in Robotics are the more important research to find the optimal solution concerning the

design of robots. The kinematic and dynamic analysis of a robot with RobotStudio software uses the real robot program, virtual controller and configuration file that are identical to the real one. Other similar assisted platforms, which were studied within the analysis of the current state, and which ensure the assisted research of robots by simulating movements, controlling spatial trajectories, solving direct (FK) and inverse (IK) kinematics through matrix-iterative methods, direct dynamics (DD) and inverse (ID), movement programming, the highlighting of Hartenberg-Denavit matrices, and based on which, after a critical analysis of their deficiencies, the own Robo-PVAFM assisted research platform was developed, are: RoboNaut [1], WorkspaceLt [2], RoboticSimulation [3], SimRobot [4], NI-Robotics [5], Open Dynamics Engine [6], Bullet Physics [7], NVidia PhysX [8] or DART [9], RoKiSim [10], RoboAnalyser [11], or ROS- Gazebo [12]. After were analyzed these software platform and some other papers from the same topics [13-29] we can do the following remarks: (i) programs provide animation of various robotic applications without considering the cases what the variation of the forces and moment to be minimum; (ii) researchers did not take into account the influence of the position of each joint of the robot on the dynamic behavior, respectively element-joint, or joint-element; (iii) researchers did not consider the influence of body size on inertia tensors and implicitly on dynamic behavior; (iv) the velocity and acceleration analysis did not highlight both the angular and the linear velocities and accelerations for each joint of the robot as well as the way in which the parameters of the trapezoidal speed characteristics influence the speed variation; (v) the influence of the movement mode respectively the simultaneous, successive or simultaneous-successive movement for various joints on the dynamic behavior was not taken into account; (vi) the research did not include the study of the influence of the up or down movement, as well as of the robot movement with and without the object to be manipulated; (vii) the influence of the dimensions of the component bodies of the robots as well as of their material on the variation of the kinetic moment and implicitly on the dynamic behavior. Compared to the analyzed software, the new proper platform Robo-PVAFM, highlights the way in which the structure of the robot, through the bodies-joints and joints- bodies matrices

used, as well as through the use of clusters, which define the type of movement, in various control options such as successive, simultaneous or their combinations, with the possibility of inserting break times in the programs, influence the dynamic behavior, as can be seen in the work. By using the new Robo-PVAFM software platform, it will be relatively easy to determine the parameters of the speed characteristics to obtain the minimal variations of the forces and moments in the joints and also the optimal position of the joints.

II. BODIES-JOINTS AND JOINTS- BODIES MATRICES

Graf associated to the analysed robot

The graph associated with one structure includes the schematic structure of the robot, in which the component bodies are defined by circles, and the joints by lines. The sense in the graph is established according to the following convention from the element to the translation joint, from the element to the rotation joint. The graph associated with the analysed articulated Arm type robot structure, fig.1 is presented in fig.2.

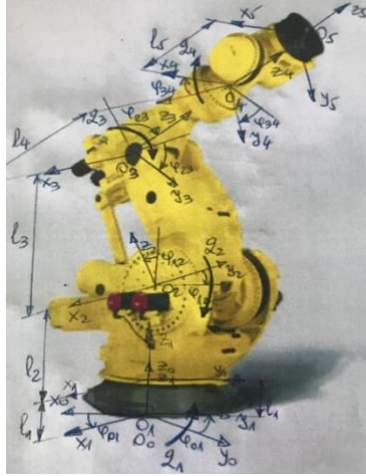

Fig.1. Cartesian systems of the analysed Arm type robot

Based on the structure of the graph, the bodies-joints and joints-bodies incidence matrices are established, which ensure the generation of the sign of the resistive forces from the robot's joints according to the Newton principle of action and reaction.



Fig.2. The graph associated to the robot's structure

Bodies-joints (B-J) and joints- bodies matrices (J-B)

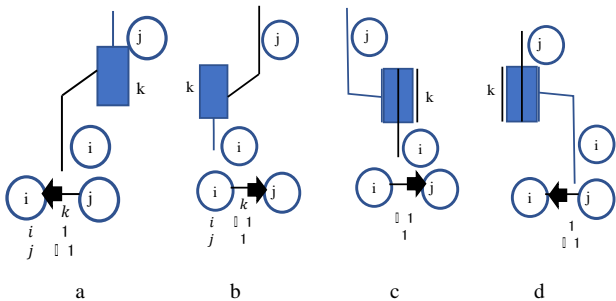

Fig.3. The position of the translation and rotation joints from the 5 classes and the sequences from the associated graph and from bodies- joints matrix: a,b- for the translation joints; c,d- for the rotation joints

The bodies-joints incidence matrix, denoted by G , has in its component only the values 0,+1,-1, depending on the way in

which the sign in the graph is associated with the structure, respectively, if the meaning is to leave the body, the value is -1, if the meaning in the graph is to enter the body, the value is +1, and if the respective couple does not connect that body, the value is 0. The matrix is denoted by G and includes only mobile bodies and non-sectioned joints. Sectioned joints are those joints that close a kinematic chain and were sectioned to create the graph tree. Based on this graph, the joints-bodies incidence matrix is also generated, denoted by Z , and which is also generated only for mobile bodies and includes elements +1, -1, 0 according to the way traveled on the graph from the body in question towards the fixed body, denoted by zero. If this way passes through the joints in the same direction as the direction in the graph, the value will be +1, if it passes in the opposite direction, -1, and if the route does not include the respective joint then the value is 0. The matrices G and Z for the analyzed structure are found in relations (1) and (2).

$$[G] = \begin{bmatrix} -1 & +1 & 0 & 0 \\ 0 & -1 & +1 & 0 \\ 0 & 0 & -1 & -1 \\ 0 & 0 & 0 & +1 \end{bmatrix} \quad (1)$$

$$[Z] = \begin{bmatrix} +1 & +1 & +1 & +1 \\ 0 & +1 & +1 & +1 \\ 0 & 0 & -1 & +1 \\ 0 & 0 & 0 & -1 \end{bmatrix} \quad (2)$$

In the mathematical model of the dynamic behavior, the matrix Z is used in the form of Z_u each of the component of Z matrix will be multiply by unit matrix in the space rel.(3).

$$[Z_u] = \begin{bmatrix} 1 & 0 & 0 & 1 & 0 & 0 & 1 & 0 & 0 & 1 & 0 & 0 \\ 0 & 1 & 0 & 0 & 1 & 0 & 0 & 1 & 0 & 0 & 1 & 0 \\ 0 & 0 & 1 & 0 & 0 & 1 & 0 & 0 & 1 & 0 & 0 & 1 \\ 0 & 0 & 0 & 1 & 0 & 0 & 1 & 0 & 0 & 1 & 0 & 0 \\ 0 & 0 & 0 & 0 & 1 & 0 & 0 & 1 & 0 & 0 & 1 & 0 \\ 0 & 0 & 0 & 0 & 0 & 1 & 0 & 0 & 1 & 0 & 0 & 1 \\ 0 & 0 & 0 & 0 & 0 & 0 & 1 & 0 & 0 & 1 & 0 & 0 \\ 0 & 0 & 0 & 0 & 0 & 0 & 0 & 1 & 0 & 0 & 1 & 0 \\ 0 & 0 & 0 & 0 & 0 & 0 & 0 & 0 & 1 & 0 & 0 & 1 \\ 0 & 0 & 0 & 0 & 0 & 0 & 0 & 0 & 0 & -1 & 0 & 0 \\ 0 & 0 & 0 & 0 & 0 & 0 & 0 & 0 & 0 & 0 & -1 & 0 \\ 0 & 0 & 0 & 0 & 0 & 0 & 0 & 0 & 0 & 0 & 0 & -1 \end{bmatrix} \quad (3)$$

The elements of the matrix G enter in the component of the matrix arm's force B , by multiplying the corresponding elements of $G_{i,k}$ with those of the matrix arm $b_{i,k}$, according to relation (4).

$$b_{i,k} = r_k - r_{gi} \quad (4)$$

$$B = \begin{bmatrix} -b_{1,1} & b_{1,2} & 0 & 0 \\ 0 & -b_{2,2} & b_{2,3} & 0 \\ 0 & 0 & -b_{3,3} & -b_{3,4} \\ 0 & 0 & 0 & -b_{4,4} \end{bmatrix} \quad (5)$$

Where: r_k^0 – position vector of the joint k ; r_{gi}^0 – position vector of the gravity center, g_i .

B^\wedge -the antisimetric matrix that provide from the vectorial product between the force's arm and force is shown in rel. (6).

$$[B^\wedge] = \begin{bmatrix} 0 & b_{1,1z} & -b_{1,1y} & 0 & -b_{1,2z} & b_{1,2y} \\ -b_{1,1z} & 0 & b_{1,1x} & b_{1,2z} & 0 & -b_{1,2x} \\ b_{1,1y} & -b_{1,1x} & 0 & -b_{1,2y} & b_{1,2x} & 0 \\ \dots & \dots & \dots & \dots & \dots & \dots \end{bmatrix} \quad (6)$$

Dynamic behaviour model with B-J and J-B matrices

The matrix for the active forces in all robot joints is shown in rel.(7).

$$(P^0) = [z_u] [(F^0) \mp [m_u] (a_{gi,0}^0)]$$

$$(F^0) = \begin{bmatrix} D_1^0 F_1^1 \\ D_2^0 F_2^2 \\ D_3^0 F_3^3 \\ D_4^0 F_4^4 \end{bmatrix}, [m_u] = \begin{bmatrix} 1 & 0 & 0 \\ 0 & 1 & 0 \\ 0 & 0 & 1 \end{bmatrix} [m_1] & 0 & 0 \\ & & & 1 & 0 & 0 \\ & & & 0 & 1 & 0 \\ & & & 0 & 0 & 1 \end{bmatrix} [m_2] \\ & & & & & & 0 & [m_{4,5}] \end{bmatrix} \quad (7)$$

where: P^0 -active forces matrix; m_u - matrix of mases; F^0 -resistive forces in all joints; $a_{gi,0}^0$ -acceleration matrix of the gravity center of i body. Active moment matrix is shown in rel.(8). For one extreme precision of the IK and DD was used some proper neural network that could be study in references [30-33].

$$(M^0) = [z_u] [(M_R^0) + (K_{gi}^{r0}) + [\hat{B}^0] (P^0)]$$

$$(M_R^0) = \begin{bmatrix} D_1^0 M_1^1 \\ D_2^0 M_2^2 \\ D_3^0 M_3^3 \\ D_4^0 M_4^4 \end{bmatrix}, [\hat{B}^0] = \begin{bmatrix} [\hat{b}_{11}^0] & [\hat{b}_{12}^0] & [\hat{b}_{13}^0] & [\hat{b}_{14}^0] \\ [\hat{b}_{21}^0] & \begin{bmatrix} 0 & -b_{22z} & b_{22y} \\ b_{22z} & 0 & -b_{22x} \end{bmatrix} & [\hat{b}_{23}^0] & [\hat{b}_{24}^0] \\ [\hat{b}_{31}^0] & \begin{bmatrix} -b_{22y} & b_{22x} & 0 \end{bmatrix} & [\hat{b}_{33}^0] & [\hat{b}_{34}^0] \\ [\hat{b}_{41}^0] & [\hat{b}_{42}^0] & [\hat{b}_{43}^0] & [\hat{b}_{44}^0] \end{bmatrix}$$

$$(b_{12}^0) = (r_{12}^0) - (r_{g1}^0)$$

$$(K_{gi}^{r0}) = \begin{bmatrix} D_1^0 K_{g1}^{r1} \\ D_2^0 K_{g2}^{r2} \\ D_3^0 K_{g3}^{r3} \\ D_4^0 K_{g4}^{r4} \end{bmatrix}, (K_{g2}^{r2}) = [J_{g2}^2] (e_{2,1}^2) + [\hat{W}_{1,0}^2] [J_{g2}^2] (W_{2,1}^2) \quad (8)$$

where: M^0 -active matrix moment; M_R^0 – resistive moment; $K_{gi,0}^0$ – matrix of variation of the cinematic moment; J_{gi}^i – tensor matrix of i body; D_i^0 - matrix of transfer between the Cartesian systems; $\mathcal{E}_{i,i-1}^i$ - angular relative acceleration matrix; $\omega_{i,i-1}^i$ - angular relative velocity matrix.

III. PROPER VIRTUAL PLATFORM ROBO-PVAFM

The proper software platform Robo-PVAFM for the Forward Kinematics (FK) and Inverse Dynamic (ID) behaviour

assisted analyse contents the mathematical matrix model transposed in the LabVIEW program for different type of robots.

The front panel of the program selected for the position analyse is shown in figs.4.

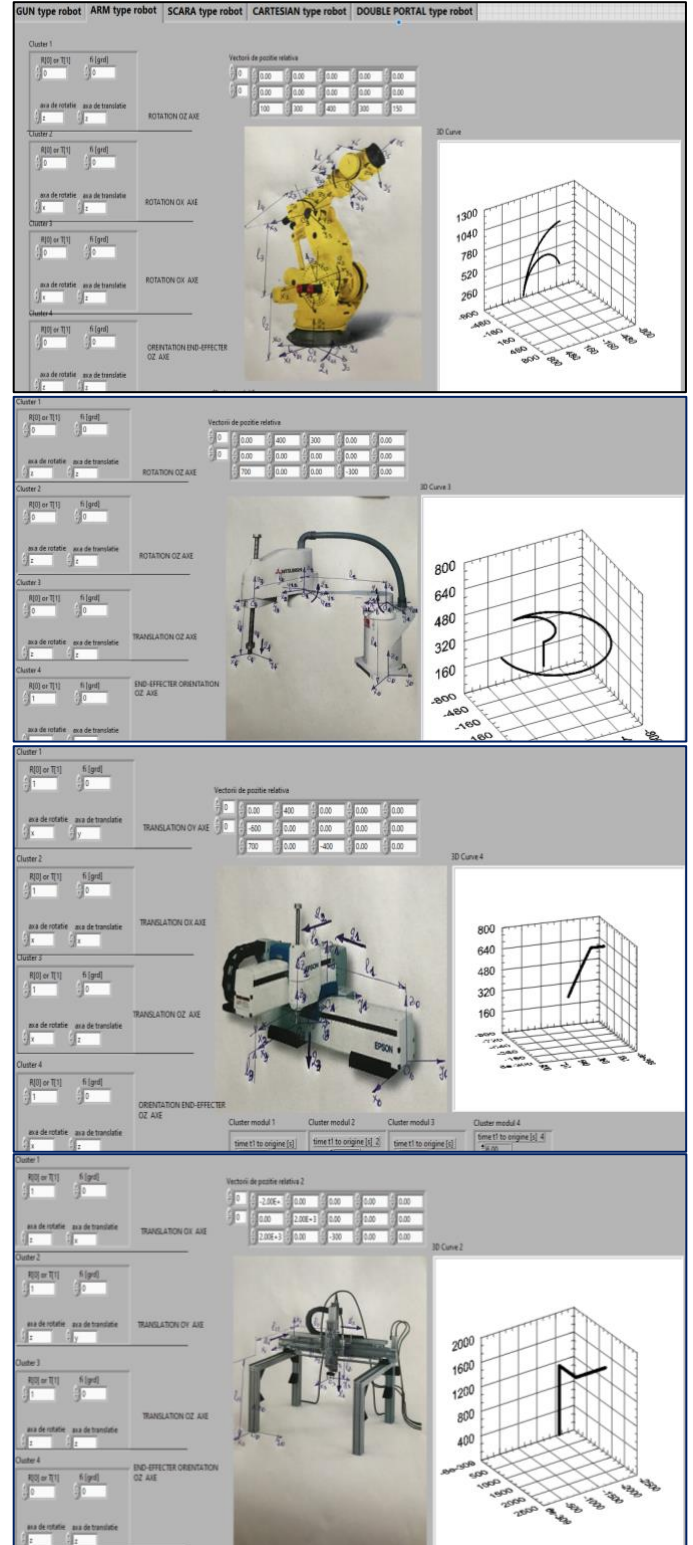

Fig.4. The front panel of the ROBO-PVAFM platform with tab control to choose the different robots for the position analyze: Arm, Scale, Cartesian, Double Portal type of robots

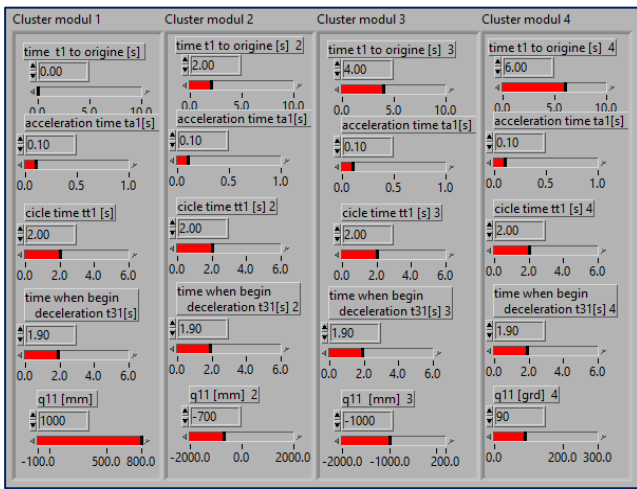

Fig.5. Clusters for the trapezoidal characteristics parameters of velocities in each robot's joints

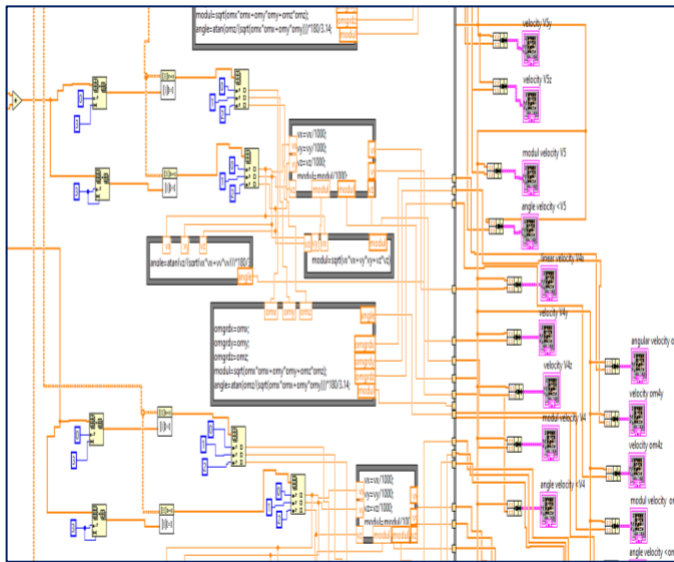

Fig. 6 Part of the block schema of the LabVIEW VI-s.

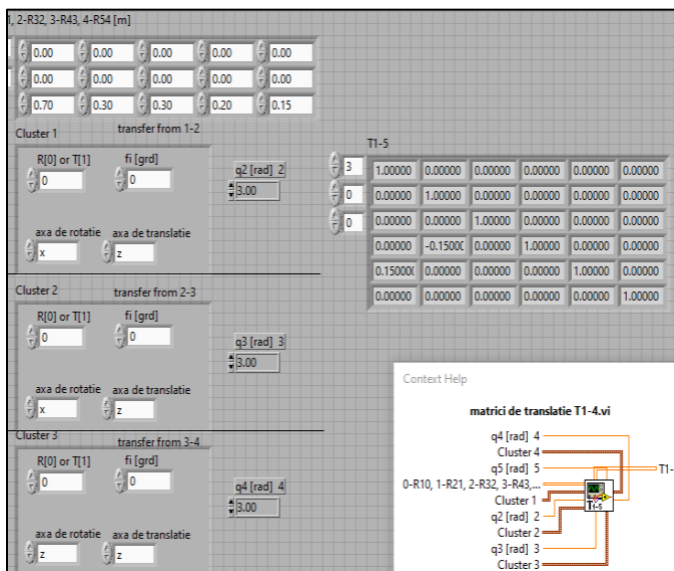

Fig.7. Front panel and icon of the subVI-s for the translation matrix T between Cartesian systems using his matrix definition.

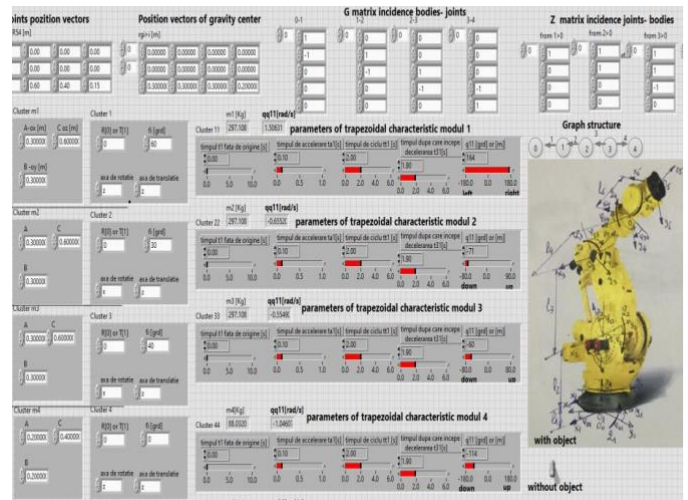

Fig.8. The front panel of the ROBO-PVAFM proper program for the assisted analyze of the positions, velocities, accelerations, forces and moments in all robot's joints selected for the Arm type robot.

In this figure we can see the clusters that define the structure of the robot like: the dimensions of all bodies; the material of the bodies; the filling coefficient of each bodies; the type of the joint and the direction of the movement; the velocity characteristics parameters; the Z and G column matrix components; the image of the studied robot with all Cartesian system applied in each robot's joints. The program, by using the dynamic behavior of the robots mathematical model, see rel.(1)-(8), shown the 3D and 2D characteristics of the positions, velocities, accelerations, forces, moments and kinetic moment variations. For the first time we can see the variation of the module and the angular position in the space of all vectors, to try to be obtained the minimum of them. The position of all joints in the structure of robot, the type of movement simultaneously, successive, or with delay of time between some movements influence the dynamic behavior like will be shown in the next chapter.

IV. SOME OF THE RESULTS OF THE ASSISTED ANALYSE

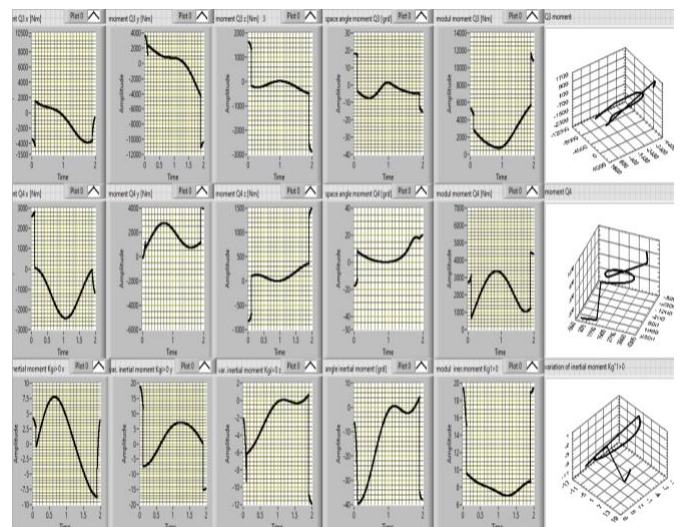

Fig.9. Front panel of the ROBO-PVAFM program with 2D and 3D characteristics of the moments in joint 3 and 4, and variation of the kinetic moment in the simultaneously movements.

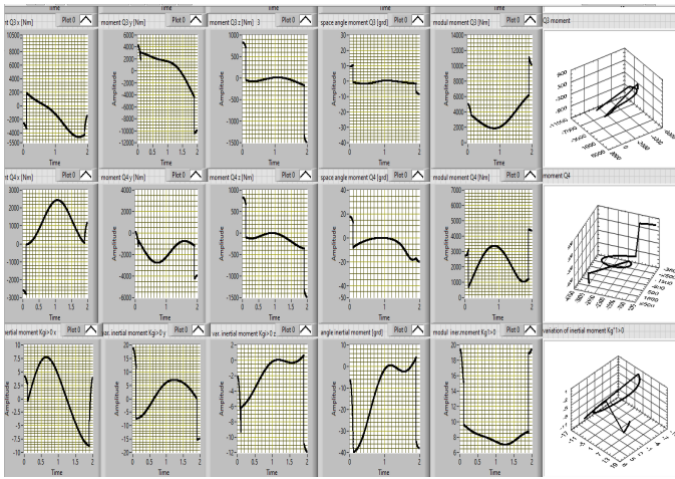

Fig.10. Front panel of the ROBO-PVAFM program with 2D and 3D characteristics of the moments in joint 3 and 4, and variation of the kinetic moment in the simultaneously movements with the changed nr.2, 3 and 4 joints position.

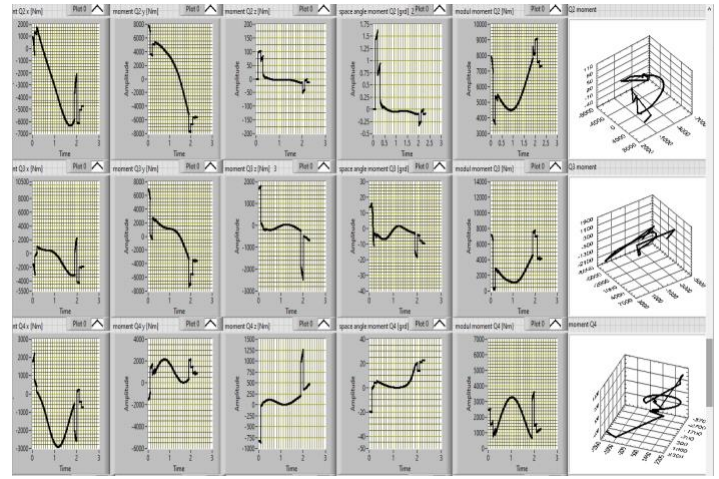

Fig.13. Front panel of the ROBO-PVAFM program with 2D and 3D characteristics of the moments in joint 3 and 4, and variation of the kinetic moment in the successive after acceleration time 0.1s and simultaneously movements.

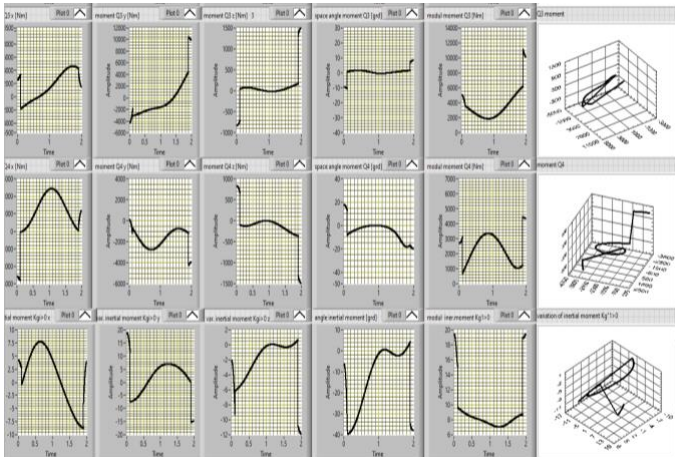

Fig.11. Front panel of the ROBO-PVAFM program with 2D and 3D characteristics of the moments in joint 3 and 4, and variation of the kinetic moment in the simultaneously movements with the changed nr.2 and 3 joints position.

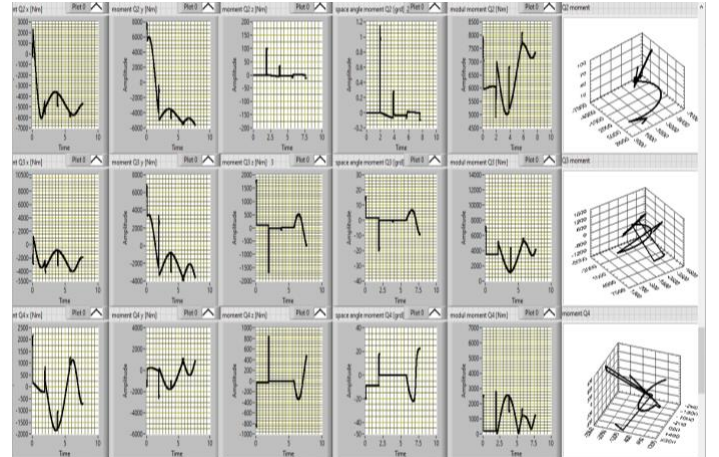

Fig.14. Front panel of the ROBO-PVAFM program with 2D and 3D characteristics of the moments in joint 3 and 4, and variation of the kinetic moment in the successive and simultaneously movements in the deceleration time 1.9-2s.

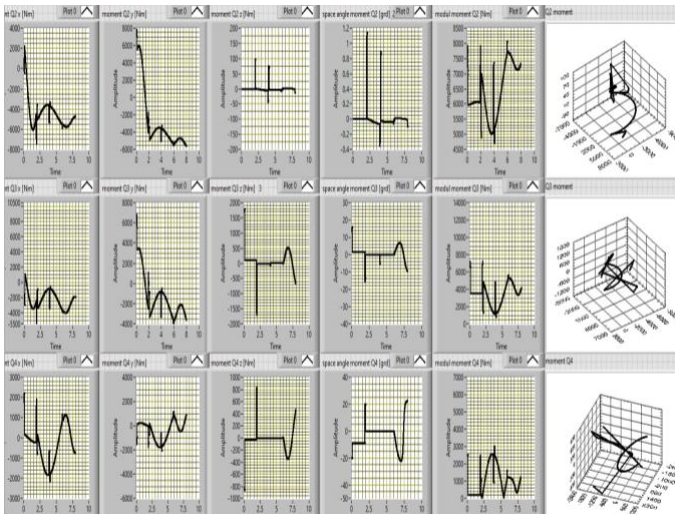

Fig.12. Front panel of the ROBO-PVAFM program with 2D and 3D characteristics of the moments in joint 3 and 4, and variation of the kinetic moment in the successive movements.

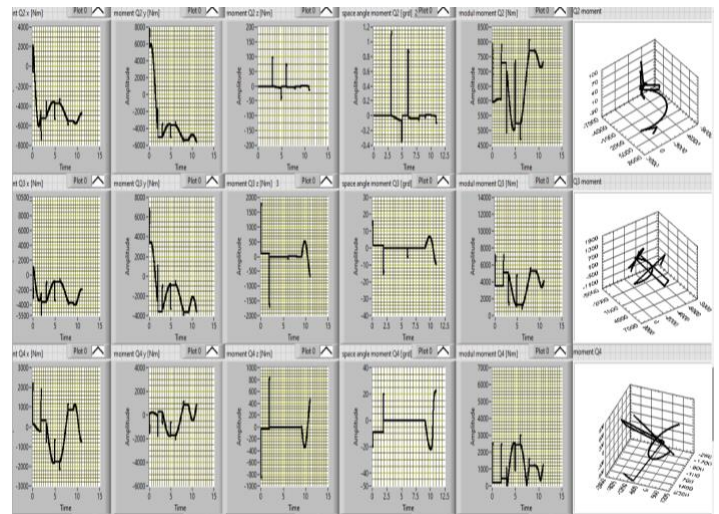
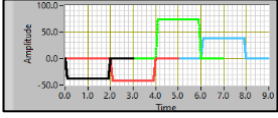
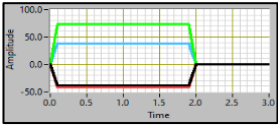
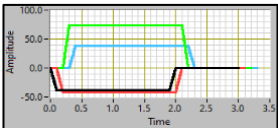
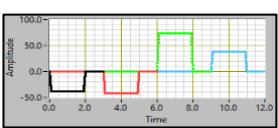
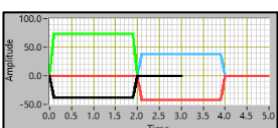
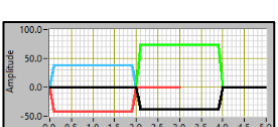
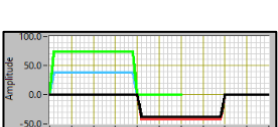
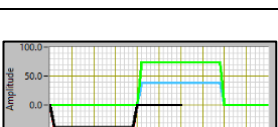
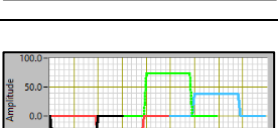

Fig.15. Front panel of the ROBO-PVAFM program with 2D and 3D characteristics of the moments in joint 3 and 4, and variation of the kinetic moment in the successive movements and time delay of 1s.

TABLE I. THE STUDIED CASES WITH DIFFERENT TYPE OF MOVEMENTS

NR. OF STUDIED CASE	TYPE OF MOVEMENT	TRAPEZOIDAL CHARACTERISTICS OF RELATIVE VELOCITIES IN ALL FOUR ROBOT'S JOINTS
1 SUCESIVE	0-2-4-6	
2 SIMULTANEOUSLY	0-0-0-0	
3 SUCESIVE AFTER THE ACCELERATION TIME	0-0.1-0.2-0.3	
4 SUCESIVE WITH ONE SECOND DELAY	0-3-6-9	
5 TWO BY TWO SIMULTANEOUSLY AND SUCESIVE	0-2-0-2	
6 TWO BY TWO SIMULTANEOUSLY AND SUCESIVE	2-0-2-0	
7 TWO BY TWO SIMULTANEOUSLY AND SUCESIVE	2-2-0-0	
8 TWO BY TWO SIMULTANEOUSLY AND SUCESIVE	0-0-2-2	
9 SUCESIVE AND SIMULTANEOUSLY WITH THE DECELERATION TIME	0-1.9-3.9-5.9	

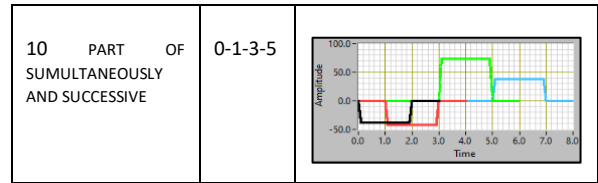

TABLE II. MIN-MAX VARIATION OF MOMENTS IN STUDIED CASES

Moment	x	y	z	<	modul
Simultaneously movement, joint position 2 and 3 were changed					
Q3	6000	14000	2250	20	8000
Q4	6000	8000	3000	40	3000
Simultaneously movement, joints in initial condition					
Q3	6000	15000	4500	35	4000
Q4	5500	4000	2250	40	3000
Successive movement, joints in initial condition					
Q3	5000	10000	3200	30	6900
Q4	4000	3000	1600	40	2500
Successive movement after 0.1s, joints in initial conditions					
Q3	4000	15000	4500	35	7000
Q4	5000	4000	2050	40	2500
Successive movement and simultaneously movement after 1.9s, joints in initial conditions					
Q3	5000	11000	3300	35	6000
Q4	4000	3000	1600	40	2500
Successive movement with 1s break, joints in initial conditions					
Q3	6500	10500	3300	30	6000
Q4	4000	3000	1600	40	2500

In the table II was shown the synthetic results concerning the maximum variation of the moments components by ox, oy, oz axes, variation of module vectors and angles with the base application plane of robot. With the blue color is the minimum variation of the Q3 moment and with yellow the minimum variation of the Q4 moment.

After were analyzed all simulation results, the synthetic table II, we can do the following remarks: (i) the best solution with the minimum variation of the moment in the end-effector joint, Q4 will be the successive movement with one second break between them; (ii) the best solution for the minimum variation of the moment in the three joint, Q3 will be the case of the simultaneously movement with changed position of joints 2 and 3; (iii) by point of view of the minimum variation of the module of moments vectors in joint 2, Q3 the best solutions are simultaneously movement with initial positions of all joints, and successive movements for end effector joint moment, Q4; (iv) the all successive movement determine increasing the proper frequency of the end-effector because the induced oscillation by variation of acceleration; (v) between the analyzed cases of simultaneously movement with joint 2 and 3 position were changed and the simultaneously movement in initial positions of the joints 2 and 3, the best one by point of view of Q3, is the case with joint 2 and 3 in new position, and by point of view of Q4 is the case without any changes of joints 2 and 3.

V. CONCLUSION

This research open the way to optimize the dynamic behavior of the industrial robots to obtain, finally the minimum variation of the velocities and accelerations in all robot's joints to obtain similar minimum variation of the forces and moments.

The complex proper platform cover the field of the research that are not researched before, like the influence of the joints positions, the type of the movements with different trapezoidal characteristics, to the forces and moments variation. The platform could be used in many other mechanical application and also will developed in the future to the multi robots applications. In the future, in this platform will be included the inverse kinematic (IK) and direct dynamic (DD) analyze.

ACKNOWLEDGMENT

The authors tanks to Techno-Accord Company from Leuval, Canada, to METRA institute of the research, Romania and to Robotics and Production System department from University Politehnica of Bucharest- for his technical sustain of this research.

REFERENCES

- [1] Robonaut. [Online]. Available: <http://robonaut.jsc.nasa.gov>.
- [2] Workspacelt. [Online]. Available: <http://www.workspacelt.com>.
- [3] Roboticsimulation. [Online]. Available: <https://robologix.com>.
- [4] Simrobot. [Online]. Available: <http://www.informatik.uni-bremen.de>.
- [5] Ni-robotics. [Online]. Available: <http://www.ni.com>.
- [6] Open dynamics engine. [Online]. Available: <http://ode.org>.
- [7] Bullet physics. [Online]. Available: <http://bulletphysics.org>.
- [8] Nvidia physx. [Online]. Available: <https://developer.nvidia.com/physx-sdk>.
- [9] Dart. [Online]. Available: <http://dartsim.github.io>.
- [10] RoKiSim. Available at: <http://www.parallemic.org/RoKiSim.html>. Accessed in June 2016.
- [11] RoboAnalyzer. Available: <http://www.roboanalyzer.com>
- [12] ROS – Gazebo Plugin, available at: <http://wiki.ros.org/gazebo>. Accessed on June 2016.
- [13] M. Quigley, K. Conley, B. Gerkey, J. Faust, T. Foote, J. Leibs, E. Berger, R. Wheeler, A. Ng, ROS: an open-source robot operating system. *In ICRA Workshop on Open Source Software*, Vol. 3, No. 3.2, 2009.
- [14] Eulalie Coevoet, Thor Morales-Bieze, Frederick Largilliere, Zhongkai Zhang, Maxime Thieffry, et al.. *Software toolkit for modeling, simulation and control of soft robots. Advanced Robotics*, Taylor & Francis, 2017, pp.1-26. hal-01649355.
- [15] Othayoth RS, Chittawadigi RG, Joshi RP, Saha SK. *Robot kinematics made easy using RoboAnalyzer software*. *Comput Appl Eng Educ*. 2017;9999:1–12. <https://doi.org/10.1002/cae.21828>.
- [16] F. A. Candelas, S.T. Puente, F. Torres, F. G. Ortiz, P. Gil, J. Pomares, *A virtual laboratory for teaching robotics*, *Int J. Eng. Educ.*, 19 (2003), 363–370.
- [17] C. A. Jara, F. A. Candelas, J. Pomares, F. Torres, *Java software platform for the development for advanced robotic virtual laboratories*, *Comput. Appl. Eng. Educ.*, 21 (2013), 14–30.
- [18] Navaraja, N.Jain, D.Sengupta, C.S.Kumar, Web based simulation and remote triggered laboratory for robots, *28th International Conference on CAD/CAM, Robotics and Factories of the Future*, 2016, 665–677.
- [19] H. D. Nayar, Robotect: serial-link manipulator design software for modeling, visualization and performance analysis, *7th Int. Conf. Control, Autom., Robot. and Vision*, 2002, 1360–1364.
- [20] M. Freese, S. Singh, F. Ozaki, N. Matsuhira, Virtual robot experimentation platform V-REP: a versatile 3D robot simulator, *Int. Conf. Simulation, Modeling, and Programming for Autonomous Robots*. 2010, 51–62.
- [21] O. Michel, *Webots: professional mobile robot simulation*, *Int J. Adv. Robot. Syst.*, 1 (2004), 39–42.
- [22] A.Gil, O.Reinoso, J.M.Marin, L.Paya, J.Ruiz, *Development and deployment of a new robotics toolbox for education*, *Comput. Appl. Eng. Educ.*, 23 (2015), 443–454. <https://doi.org/10.1002/cae.21615>.
- [23] S. Kucuk, Z. Bingul, *An off-line robot simulation toolbox*, *Comput. Appl. Eng. Educ.*, 18 (2010), 41–52.
- [24] M.Flanders, R.Kavanaugh, *Build-A-Robot:using virtual reality to visualize the Denavit– Hartenberg parameters*, *Comput. Appl. Eng. Educ.*, 23 (2015), 846–853.
- [25] J. Denavit and R. S. Hartenberg, A Kinematic Notation for Lower-Pair Mechanisms Based on Matrices, *Trans. of ASME, Journal of Applied Mechanics*, 23:215–221.
- [26] Asada, H., A geometrical representation of manipulator dynamics and its application to arm design, *Transactions of ASME, Journal of Dynamic Systems., Meas. and Control*, Vol. 105, pp. 131-135. 1983.
- [27] Bowling A., Analysis of robotic manipulator dynamic performance: Acceleration and force capabilities, PhD-thesis, Stanford University. 1998.
- [28] Kahn W.A. and Angeles J., The kinetostatic optimization of robotic manipulators: the inverse and the direct problems, *Transactions of the ASME Journal of Mechanical Design*, Vol.128, No.1, pp.168-178, 2006.
- [29] Salisbury, J. K., and Craig, J. J., Articulated Hands: Force Control and Kinematic Issues, *International Journal of Robotics Research*, Vol.1, No.1, pp.4–17, 1982.
- [30] Olaru, A, Olaru, S. and Mihai, N., Proper Assisted Research Method Solving of the Robots Inverse Kinematics Problem, *Applied Mechanics and Materials*, 555 (2014) 135-147.
- [31] A. Olaru, S. Olaru, L.Ciupitu, Assisted research of the neural network by back propagation algorithm, *OPTIROB 2010 International Conference*, Calimanesti, Romania, The Research Publishing Services Singapore Book, (2010) 194-200.
- [32] A. Olaru, S. Olaru and N. Mihai, Proper Assisted Research Method Solving of the Robots Inverse Kinematics Problem, *Applied Mechanics and Materials*, vol.555, 2014, 135-147.
- [33] A. Olaru, S. Olaru and L. Ciupitu, Assisted research of the neural network by back propagation algorithm, *OPTIROB 2010 International Conference*, Calimanesti, Romania, May 28th–30th, 2010, The Research Publishing Services Singapore Book, ISBN 978-981-08-5840-7, Editors: A. Olaru, L. Ciupitu, and S. Olaru, pp. 194-200, 2010.